

VISION 8

8 zone hardware control panel

Summary	Page
1.0. Description	2
2.0. Installation	3
3.0. Connections	4
4.0. Mains power connection	7
4.1. Mains power fuse change	7
4.2. Ground connection	7
5.0. Front panel	8
6.0. Zone description	9
6.1. Double balanced connection	9
7.0. Electronic key	10
7.1. Remote receptacle installation	10
8.0. Electronic key sabotage	11
9.0. Mechanical switch lock key	11
10.0. Remote keypad Digit-KD	12
11.0. Maintenance mode	13
12.0. Programming	14
12.1. 1 st phase - Options configuration	15
12.2. 2 nd phase - Self learning of electronic key and keypad	16
12.3. 3 rd phase - Zone programming L1 → L8 (NC or balanced)	17
12.4. 4 th phase - Immediate / Delayed zones configuration	18
12.5. 5 th phase - Grouping up zones for Day / Night arming	19
12.6. Exiting the programming mode	19
13.0. Factory setting	20
14.0. Total arming (Day mode)	21
15.0. Partial arming (Night mode)	23
16.0. Arming Test-Control (Day mode)	24
17.0. Arming Test-Control (Night mode)	26
18.0. Disarming	27
19.0. By-passing zones	29
19.1. Exiting by-pass mode	30
20.0. Hold-up function	31
20.1. Reset hold-up function	31
21.0. Alarms order or priority	32
22.0. Recyclable and non recyclable alarm	33
23.0. Alarm procedure	34
24.0. Automatic zone exclusion	35
25.0. Alarm memory	36
26.0. Low battery	37
27.0. Technical characteristics	38

ENGLISH

Congratulations on your purchase of the VISION 8, an advanced hardwire control panel. The unit has been built using the most advanced microprocessor technology and production methods. Being tested by means of special computerized test jig, the VISION 8 offers security and durability in time.

1.0. DESCRIPTION

The VISION 8 is an hardwire alarm control panel with 27 zones divided as follows:

- The first **8 zones** are programmable and may be configured as immediate, delayed, Day, Night, normally closed (N.C.), double balance using 2 wires, with by-passed and automatic exclusion after 4 consecutive alarm cycles.
- The other **3 zones (*tamper, fire and hold-up*)** are immediate, balanced, not programmable and ***always active***.

A 16 x 2 character alphanumeric LCD display facilitates programming and supplies all information regarding the control panel and status of the sensors installed. It allows also visualization of the alarm memory.

The self learning feature of the electronic key and remote keypad makes installation easier and the microprocessor control assures intelligent elaboration of the signals: the software filters all inputs and automatically excludes faulty inputs, eliminating the major causes of false alarms.

Arming and disarming the control panel may be done by the electronic key supplied directly on the unit's front panel, by remote electronic key (optional), or by remote LCD keypad (optional).

The control panel also has a Test mode which allows the installer to understand if the panel is in alarm status through an incorporated buzzer. This feature is sometimes called "chime".

The creation of a group of zones that function in Day or Night permits you to rapidly arm the control panel without modifying the way the panel has been programmed.

Signalling of a zone open that has not been previously excluded, avoids annoying false alarms caused by end users distractions during the arming of the control panel.

Unauthorized attempts to arm the control panel will activate the anti-tamper zone which will block the use of the electronic key and at the same time trigger the alarm.

During Maintenance mode it is easy to verify the activity of the zones and the efficiency of the battery without activating the sirens and permits you to work on the control panel without disconnecting the mains power.

The extreme flexibility of the different programming methods allows the end user to personalize the installation based on his needs.

Other characteristics

- Alarm priority
- By-pass of all burglary alarm zones
- Separate relay alarm outputs recyclable and non recyclable
- Delay zone audible pre-alarm
- Remote indication for alarm status armed /disarmed and memory status of each zone
- Low battery indication
- Output terminals for sirens with or without battery back up
- Output terminals to activate telephone dialler, indicating alarm, low battery and tamper.

The VISION 8 is available in ABS housing capable of lodging a battery 12 V - 7 Ah max or steel housing capable of lodging a battery 12 V - 17 Ah max.

The control panel is supplied with electronic key receptacle on the panel and 2 SK-8 keys.

2.0. INSTALLATION

For an easy and correct installation follow the steps listed below:

- 1) Remove the control panel cover.
- 2) Fix the base of the panel to the wall.
- 3) Install and connect all the sensors and sirens to the control panel terminal block.
- 4) Connect the mains 230 Vac power source to the 3 terminals indicated on the right. Be sure to connect a good ground source to the centre terminal.
Be careful that the cable being connected is without power.
- 5) Connect the battery using the red and black terminals (red for positive and black for negative).
On the display of the control panel and of the Digit-KD the message seen on the right appears and the "TEST" LED on the remote key pad flashes slowly to indicate that the control panel is in **Maintenance mode**.
- 6) Re-position and fix the control panel cover.
- 7) Connect the mains power input wire to a 230 Vac source. **It is suggested that this power source be obtained between the AC power meter and the main circuit breaker.** After this is done, the green LED "POWER" will light up.
- 8) Be sure that the 24 hour tamper line is closed (LED "TAMPER" off on the Digit-KD).
- 9) Press the "B" button for at least 5 seconds to obtain all factory settings.
- 10) Press the "A" button for at least 3 seconds to enter into **Programming mode**.
- 11) **Program** the control panel following the instructions on Page 14.
- 12) Once the control panel is programmed, exit the **Programming mode**. The control panel will go into Maintenance mode.
- 13) Insert an electronic key into the receptacle on the front panel or remote position, or press the "access code" + "#" on the Digit-KD. The control panel will go into disarmed mode.
- 14) To arm the control panel in Day or Night mode insert an electronic key into the receptacle on the front panel or remote position, or press the "access code" + "#" on the Digit-KD. The control panel emits a beep and after the exit time it becomes active.

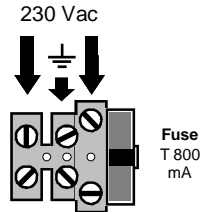

ENGLISH

3.0. CONNECTIONS

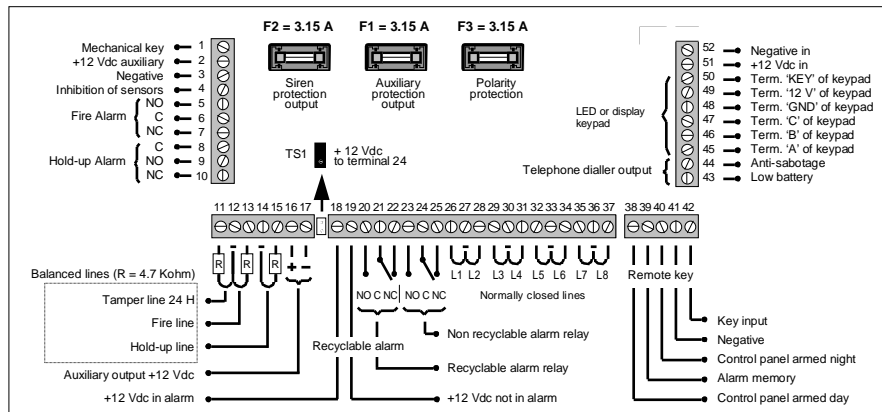

- 1 3 - Output for remote switch lock key.
If the control panel has been armed with a switch lock key it is not possible to disarm it with an electronic key or vice-versa.
- 2 3 - Auxiliary output 12 Vdc.
+ - **This output is always active with control panel armed or disarmed.**
- 4 - Positive output (+ 12 Vdc) used to deactivate sensors (infrared, microwave, etc)
When the control panel is disarmed +12 V dc is present. At the end of the exit time the +12Vdc disappears.
- 5 6 7 - Normally opened (N.O.) - Common (C) - Normally closed (N.C.).
Volt free relay contact for fire / gas alarm - (*I_{max} 8 Amp*).
When triggered, this relay is activated for 30 or 60 seconds (see paragraph 23.0).
- 8 9 10 - Common (C) - Normally opened (N.O.) - Normally closed (N.C.)
Volt free relay contact for panic alarm - (*I_{max} 1 A*). When triggered, this relay is activated for 30 or 60 seconds (see paragraph 23.0) - (panic audible and non audible).
- 11 12 - 24 H anti-tamper balanced line with end of line resistor 4.7 K ohm.
+ - **With control panel armed or disarmed, unbalancing this zone will cause:**
 - Slow flashing of the "TAMPER" LED on the remote keypad and slow flashing of the message "tamper wire" on the display of the control panel and on the remote keypad. The LED and the message continue flashing after disarming the control panel (alarm memory). The Alarm memory will stop flashing only after the control is armed once again.
 - The lighting of the "Alarm memory" LED on the electronic key receptacle. It remains lit even after control panel disarmed and will go off only after re-arming.
 - The activation for 30 or 60 seconds of the output for the telephone dialler (Terminal 44).
 - The activation for the time of alarm programmed for the incorporated buzzer and for the relays of recyclable alarm (Terminals 18,19,20,21,22) and non recyclable alarm (Terminals 23,24,25).

- 13 14 - Fire or gas balanced line with end of line resistor 4.7 K ohm.
+ -
- With control panel armed or disarmed, unbalancing of this zone will cause:**
- The slow flashing of the “FIRE” LED on the remote keypad and the slow flashing of the message “fire wire” on the display of the control panel and on remote keypad. The LED and the message continue flashing even after having disarmed the control panel (Alarm memory) and will go off only after having armed the control panel once again.
 - The lighting of the “Alarm memory” LED on the electronic key receptacle. It remains lit even after control panel disarmed and will go off only after re-armed.
 - The activation for 30 or 60 seconds of the fire output relay (Terminals 5, 6, 7).
 - The activation for the time of alarm programmed for the incorporated buzzer and for the relays of recyclable alarm (Terminals 18,19,20,21,22) and non recyclable alarm (Terminals 23,24,25).
- the
- 15 14 - Hold-up balanced line with end of line resistor 4.7 K ohm.
+ -
- With control panel armed or disarmed, unbalancing of this zone will cause:**
- The slow flashing of the “TAMPER” LED on the remote keypad and the slow flashing of the message “hold-up wire” on the display of the control panel and on the remote keypad. The LED and the message continue flashing even after having disarmed the control panel (Alarm memory) and will go off only after having armed the control panel once again.
 - The lighting of the “Alarm memory” LED on the electronic key receptacle. It remains lit even after control panel disarmed and will go off only when re-armed.
 - If you have programmed a **silent hold-up** alarm, after this alarm has been triggered only the panic relay will activate (Terminals 8,9,10) for 30 or 60 seconds.
 - If you have programmed an **audible hold-up** alarm, triggering this alarm will activate the hold-up alarm relay as above and also the recyclable and non recyclable relays (Terminals 18 to 25) and the incorporated buzzer will sound for the pre-programmed time.
- 16 17 - 12 Vdc auxiliary output - ($I_{max} 1.2 A$).
+ -
- This output is always active, with control panel armed or disarmed.**
- 18 - +12 Vdc present in case of burglary, tamper, fire, or audible panic alarms.
Recyclable alarm. Output for sirens without battery back up.
- 19 - +12 Vdc (PS) present in non alarm status.
The positive disappears if the following alarms are triggered: burglary, tamper, fire, audible hold-up (recyclable alarm). Output for sirens with battery back up.
- 20 21 22 - Volt free relay contact output for **recyclable alarm** - ($I_{max} 8 A$).
Normally opened (N.O.) - Common (C) - Normally closed (N.C.).
This relay is activated if burglary, fire, tamper or audible panic alarms are triggered.
- 23 24 25 - Volt free relay contact output for **non recyclable alarm** - ($I_{max} 8 A$).
Normally opened (N.O.) - Common (C) - Normally closed (N.C.).
This relay is activated if burglary, fire, tamper or audible panic alarms are triggered.
Placing a bridge on the connector TS1, the common of the relay (Terminal 24) will be connected to +12 Vdc.
- 26 27 - L1 - Programmable Normally Closed (N.C.) or double balanced line.
+ -
- With the control panel armed, opening of this zone will cause:**
- The slow flashing of the message that indicates the zone in alarm (for example “Z.1 filo”) on the display of the control panel and of the remote key pad.
The message continues flashing even after having disarmed the control panel (Alarm memory) and it goes out only after having armed the control panel once again.

ENGLISH

- The lighting of the “**Alarm memory**” LED on the electronic key receptacle. It remains lit even after the panel is disarmed and will go off only when re-armed.
- The activation for 30 or 60 seconds of the output for the telephone dialler (Terminal 44).
- The activation for the time of alarm programmed for the incorporated buzzer and for the relays of recyclable alarm (Terminals 18,19,20,21,22) and non recyclable alarm (Terminals 23,24,25).

With the control panel disarmed, opening of the NC zone will cause:

- The message “**zone in alarm**” on the display of the control panel and Digit-KD will appear for the entire time that the zone remains triggered.

Note: What has been written for N.C. L1 is valid also if you use the double balanced line. The only difference is that the control panel is capable of distinguishing the difference between a tamper alarm from a burglary alarm (see paragraph 6.1.).

What has been written for L1 is valid for all 8 lines (Terminals 26 to 37).

- 38** - Output for remote LED that indicates control panel “**Armed Day mode**”. This LED is located on the remote electronic key receptacle (see connections on page 10).
- 39** - Output for remote LED that indicates “**Alarm Memory**”. This LED is located on the remote receptacle of the electronic key (see connections on page 10).
- 40** - Output for remote LED that indicates control panel “**Armed Night mode**”. This LED is located on the remote electronic key receptacle (see connections on page 10).
- 41** - Negative
- 42** - Remote electronic key input (see connections on page 10).
- 43** - Negative output to signal low battery of the control panel - (*Imax 100 mA*). The output remains active for 30 or 60 seconds (see paragraph 23.0). This output may be used for the activation of a telephone dialler.
- 44** - Negative output for the indication of burglary alarm and tamper alarm of the control panel and sensors - (*Imax 100 mA*). The output remains active for 30 or 60 seconds (see paragraph 23.0). This output may be used for the activation of a telephone dialler.
- 45** - Connect to the terminal marked “**A**” of the remote keypad (see Digit-KD instructions).
- 46** - Connect to the terminal marked “**B**” of the remote keypad (see Digit-KD instructions).
- 47** - Connect to the terminal marked “**C**” of the remote keypad (see Digit-KD instructions).
- 48** - Negative
- 49** - + 12 Vdc - Power output for remote keypad.
- 50** - Connected to the terminal marked “**KEY**” of the remote keypad (see Digit-KD instructions).
- 51** - Power input for control panel +12 Vdc.
- 52** - Terminal for negative connection.

FUSES

- F1 = 3.15 A** - Rapid fuse to protect the 12 Vdc auxiliary outputs (Terminals 2, 16, 49).
- F2 = 3.15 A** - Rapid fuse to protect the siren outputs (Terminals from 18 to 25).
- F3 = 3.15 A** - Rapid fuse to protect polarity inversion of the battery.

4.0. MAINS POWER CONNECTION

Before making this connection make sure that the cable being use is volt free and be sure to insert the bare wire completely into the terminal block as shown on the right.

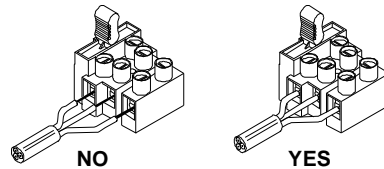

Presence of main power can be seen on the panel when the green "POWER" LED lights up.

4.1. MAINS POWER FUSE CHANGE

One of the two phases of the mains power is protected by a retarded fuse T800 mA.

The fuse is incorporated in the terminal block seen on the right hand side.

In case of fuse burn out, it can be easily changed by sliding upward the fuse holder as shown on the right.

Change the fuse and plug it back in with downward pressure.

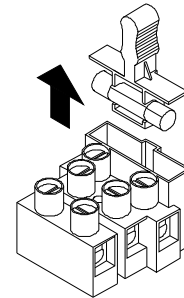

4.2. GROUND CONNECTION

It is important to have a good ground connection to avoid electrical disturbances to the control panel.

Therefore the terminal indicated as ground (see on the right) *must be connected to a good ground connection.*

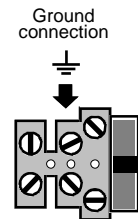

ATTENTION

*Electrical building installation must be equipped with a bipolar automatic switch.
In case of ordinary maintenance, disconnect the unit from the mains.*

ENGLISH

5.0. FRONT PANEL

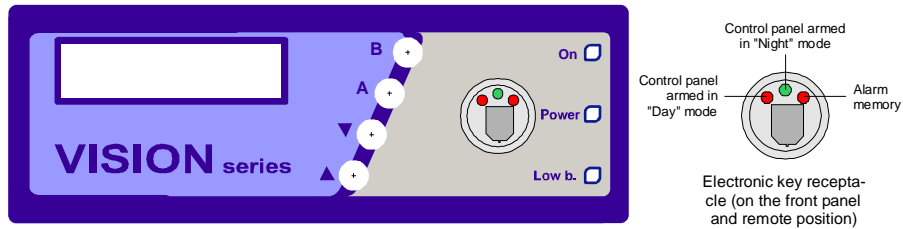

"POWER" LED
Maintenance mode, control panel armed and disarmed:
1) Always lit signals 230 Vac present.

"LOW BATTERY" LED (on front panel and remote keypad)
Maintenance mode:
1) Always lit indicates low battery.
Programming mode:
1) Always lit indicates panel learning electronic key code.
2) Quick flashing indicates configuration of balanced zones.
Control panel disarmed or armed (Day / Night):
1) Slow flashing indicates low battery.

Led "ON" (on front panel, electronic key receptacle and remote keypad)
1) Flashes quickly during exit time. After exit time it will light up until control panel is disarmed.
2) If when control panel is armed a line is open or unbalanced, the LED flashes slowly during the exit time, then it will light up until panel is disarmed.

"Alarm memory" LED (on receptacle of electronic key)
1) Always lit until the next arming signals alarm memory.
2) Slow flashing during the exit time signals zone by-passed or automatic cut-off.

"Arming Night mode" LED (on receptacle of electronic key)
1) Always lit during the exit time.
2) At the end of the exit time it will go out until the next time the control panel is armed.

DISPLAY
Maintenance mode:
1) Visualizes the status of the control panel and all zones.
Programming mode:
1) Accompanies the user in all the programming phases and facilitates the process.
Control panel disarmed or armed (Day / Night):
1) Visualizes the status of the control panel, the violated zones and alarm memory.

"FORWARD" ▲ and "BACKWARD" ▼ BUTTONS
1) Buttons for the visualization and running of the menus. In the menu visualized on the display the entire list of all zones, low battery (**Bat**), tamper zone (**Tmp**) and fire zone will appear. The menu may be visualize independently from the status of the control panel (maintenance mode, disarmed, armed in Day mode, armed in Night mode and Test-control mode).

PUSH BUTTON "A" and "B"
1) Are used to change the state of the control panel mode or programming status.
Ex: you may go from Maintenance mode to Programming mode or to the next programming status while in programming mode, by-pass the zones, insert the control panel in test-control mode, return the panel to factory setting.

ARMING / DISARMING KEY
1) Receptacle on the panel with 2 keys are factory supplied. Remote receptacle is available upon request.
2) The control panel may be armed also with switch lock or remote keypad (optional).

6.0. ZONE DESCRIPTION

The VISION 8 is supplied in total of 11 zones:

- The first **8 zones** (L1 → L8 - Terminals 26 to 37) may be programmed as immediate, delayed, Day, Night, normally closed (N.C.), double balance using 2 wires, with by-passed and automatic exclusion after 4 consecutive alarm cycles .
The control panel is supplied with the zone L1 → L8 all normally closed (NC).
- The remaining **3 zones** (**tamper**, **fire** and **hold-up** - Terminals 11, 12, 13, 14 and 15) are immediate, balanced (resistance 4.7 K ohm), not programmable and **always active**.

6.1. DOUBLE BALANCED CONNECTION

For double output sensors (alarm relay and sabotage output) double balanced, the VISION 8 is capable of distinguishing burglary alarm from tamper alarm with indication that if both alarms trigger, the sabotage alarm prevail.

Double balanced connection has only two wires as indicated on the right.

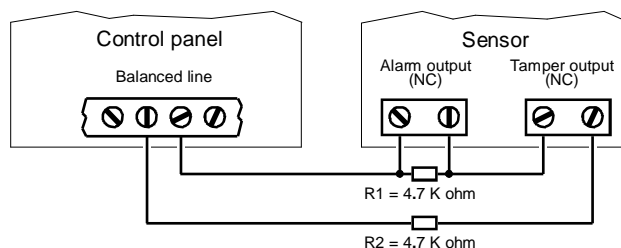

- In absence of alarms, the control panel reads only a resistance of 4.7 K ohm (R2).
- In case of burglary alarm, the control panel reads a resistance of 2×4.7 K ohm (R1+R2).
- In case of tamper alarm, the control panel reads a resistance of unlimited value.

ATTENTION

Double balanced sensors free of tamper output must be connected in a way that, in case of alarm, the control panel in any case reads a resistance of 2×4.7 K ohm (R1 + R2) (see figure on the right).

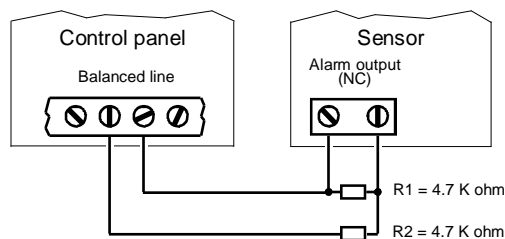

ATTENTION

If the control panel reads a resistance different from 4.7 K ohm or 2×4.7 K ohm (short circuit), then it will also trigger a tamper alarm.

ATTENTION

For the alarm to be triggered, the line must remain open for more than 0,4 sec.

ENGLISH

7.0. ELECTRONIC KEY

The VISION 8 may be armed and disarmed through the electronic key situated on the front panel, with a remote electronic key (optional), or with a remote LCD keypad Digit-KD (optional). Also available upon request are receptacles series Magic (SK-8M) and Living (SK-8L).

The control panel is factory supplied with an electronic key and 2 keys.

The control panel can self learn and memorize up to 8 different codes (between electronic keys and remote keypads). For every code, you may use an unlimited amount of keys or keypads.

On the receptacle there are 3 LEDs that signal "Control panel armed Day mode", "Control panel armed Night mode" and "Alarm Memory" (see figure on right).

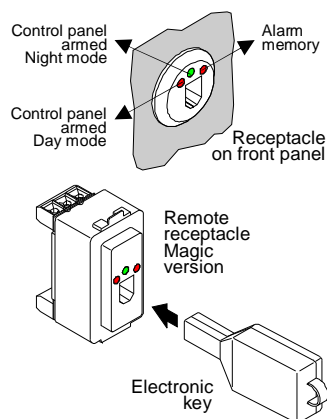

■ LED "Control panel armed Day mode" (Red)

Has the same functions as LED "ON" on the front panel.

When the electronic key is inserted, the LED emits the following signal:

- 1) Fast flash during exit time. After exit time has expired always lit until panel is disarmed.
- 2) If option 8 is not active (see paragraph 12.1.) and when you arm there is an open zone, the LED will flash slowly for a few seconds and then will go off, this indicates panel not armed.
- 3) If option 8 is active and when you arm there is a zone open, the LED will flash slowly and after it will go on until the control panel is disarmed.
- 4) This LED has the same function even in the case of "Night" mode arming.

■ LED "Control panel armed Night mode" (Green)

Inserting an electronic key for at least 5 seconds provokes:

- 1) The lighting of the green LED and the quick flashing of the red LED "Control panel armed Day mode" (see points (1), (2), and (3) of the previous paragraph).
- 2) At the end of the exit time, the green LED goes out, while the red LED remains lit until the control panel is disarmed.

■ LED "Alarm Memory" (Red)

- 1) The LED will flash slowly during exit time if there are zones by-passed.
- 2) Red LED "ON" fixed after every alarm indicates alarm memory. To switch off this memory, re-arm the panel.

7.1. Remote receptacle installation

To allow arming of the control panel from more than one remote position it is necessary to hardwire to Terminals 38, 39, 40, 41 and 42 of the VISION 8 to the terminals on the back side of the receptacle as shown in the figure on the right.

The figure on the right is refer to Magic version receptacle.

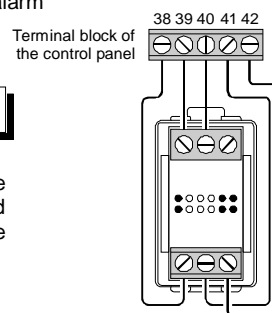

8.0. ELECTRONIC KEY SABOTAGE

- The control panel has built-in protection against the use of false electronic keys.
- If the control panel will recognises the insertion of a key with an unknown code, if there are several attempts of sabotage, it will then ignore all of the following keys used (**key block**). The blockage time depends on if the unknown key remains inserted, or if it is taken out and a valid one is inserted.
- If subsequently, the control panel recognises another attempt to insert a false electronic key, the tamper alarm will activate (see point (1) of the paragraph 18.0.).

ATTENTION

Even if the control panel is armed with a switch lock key, the sabotage of the electronic key is always in operation.

9.0. SWITCH LOCK KEY

The VISION 8 may be armed/disarmed by means of a switch lock key connected to Terminals 1 and 3.

- Using a switch lock key only total arming/disarming is possible ("Day" position and "OFF" position). Night arming is not possible.
- If the control panel has been armed with a switch lock key (Terminals 1 and 3 closed), it is not possible for the control panel to be disarmed by using an electronic key or remote keypad.
- If the control panel has been armed with the electronic key or remote keypad and you attempt to rotate the switch lock key, the control panel will not function any longer with the electronic key or remote keypad.
- Even if the control panel has been armed with switch lock key the anti-sabotage of the electronic key is always in operation.

ENGLISH

10.0. REMOTE KEYPAD *Digit-KD*

The VISION 8 can be armed in Day mode, Night and Test-control, disarmed and zone by-passed using the LCD keypad with 16x2 characters display.

The remote keypad can not be used to program the control panel.

On the left hand side of the keypad you will see the following optical signalling:

- **Unit ON** Control panel armed
- **Tamper** Tamper alarm
- **Fire** Fire alarm
- **Low Bat.** Low battery
- **Test** Test-control

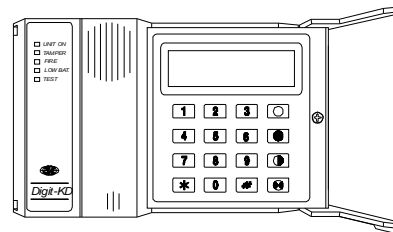

The display will show how the control panel has been programmed and in addition shows all the information related to the control panel status and its 11 zones (Memory and Test).

- **Panel armed day** → Digit **access code** and then #
- **Panel armed Night** → Digit **access code** and then # + ●
- **Test-Control armed** → Digit **access code** and then # + ● (during exit time)
- **Panel disarmed** → Digit **access code** and then #
- **To by-pass zones** → Digit **access code** and then # + ● (within 5 seconds)

For better comprehension see keypad instruction manual.

11.0. MAINTENANCE MODE

With the control panel in this mode it is possible to:

- 1) **Open the control panel without triggering an alarm**
- 2) **Enter into the programming mode** (by pressing the key "A" for at least 3 sec.)
- 3) **Re-set all functions to factory status** (by pressing the key "B" for at least 3 sec.)

Maintenance mode is indicated by a slow flashing LED "TEST" on the remote keypad

■ **To enter into Maintenance mode**

- Every time the control panel is powered up, it goes **automatically** into Maintenance mode (on the display of the control panel and Digit-KD will appear the message on the right).
- To go from control panel disarmed to Maintenance mode, you must insert a programmed electronic key into the receptacle on the panel and, within 5 seconds, press simultaneously the buttons "A" and "B". The control panel will go into Maintenance mode. The "TEST" LED on the remote keypad will flash slowly.

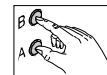

■ **To exit maintenance mode**

- Insert a programmed electronic key into the receptacle on the panel or remote position, or digit the "access code" and then "#" on the remote keypad. The control panel will exit the Maintenance mode and go directly into **disarmed mode without emitting any beep** (on the display of the control panel and Digit-KD appears the message on the right). The "TEST" LED on the remote keypad will go off.



ATTENTION *If after the VISION 8 is powered up, the control panel will not go into Maintenance mode, you must remove power and re-power keeping the "B" button pressed.*

ATTENTION *While in Maintenance mode, the functions of zone by-pass and auto-matic cut-off of a zone after 4 alarm cycles are not active.*

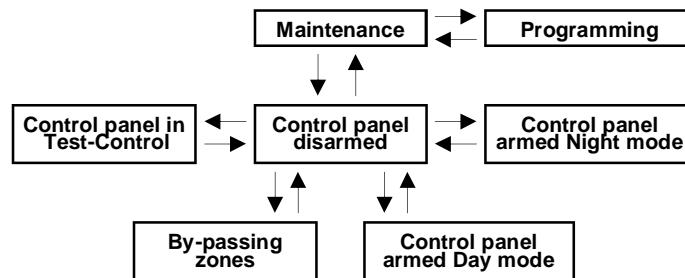

ENGLISH

12.0. PROGRAMMING

With the control panel in Maintenance mode it is possible to entry into Programming mode and execute the following operations:

1^a Phase - Options:

- 1) Type of code used with the electronic key 34 bit (factory setting - 34 bit)
- 2) The alarm transmission to wireless sirens, "yes" or "no" (factory setting yes)
- 3) Entrance time 10 or 20 seconds (factory setting - 10 sec.)
- 4) Silent or audible pre-alarm (factory setting - silent)
- 5) Alarm time 90 or 180 seconds (factory setting - 90 sec.)
- 6) Automatic zone cut-off after 4 alarm cycles (factory setting - yes)
- 7) Hold up, silent, or audible (factory setting - silent)
- 8) Arming of control panel with zones in alarm, tamper alarm or low battery (factory setting - the control panel does not arm)

2nd Phase - Self learning electronic key and keypad code

("LOW B." LED lit on the panel and remote keypad)

3rd Phase - Configuration of balanced zones

("LOW B." LED flashing on the panel and remote keypad)

4th Phase - Configuration of delayed zones

("TAMPER" LED flashing on the remote keypad)

5th Phase - Zones associated to Night

("FIRE" LED flashing on the remote keypad)

ATTENTION In order to program the above, you must follow the sequence of the 5 phases as shown above.
The "TEST" LED on remote keypad will flash quickly during all phases.

■ To enter into programming mode:

- With the control panel in Maintenance mode, press the button "A" for 3 seconds. A beep from the incorporated buzzer will be emitted.
- The red LED "TEST" on the Digit-KD will flash quickly. On the display of the control panel and Digit-KD will appear the message on the right. This indicates that the control panel has entered in programming mode.



PROG OPTION
code 34 bits

■ To exit programming mode:

- It is not possible to exit the programming mode until the 5th phase has been completed.
- To exit programming mode, keep pressed button "A" and simultaneously press once button "B". The control panel will automatically return in Maintenance mode (the LED "TEST" flashes slowly on the remote keypad).



12.1. 1st Phase - OPTIONS CONFIGURATION

As soon as you enter to programming mode, on the display will appear the message related to the first option memorized that is the number of bits (34) regarding the code to self learned. All the options are listed on the table below.

PROG OPTION
code 34 bits

During the time of this first phase, the LED "TEST" will flash quickly on the remote keypad.

Option	Function	Message on the display Factory settings	Programmable settings
Option 1	Code of electronic key and keypad	code 34 bit	34 bit
Option 2	Wireless siren (only for wireless control panel)	siren rf si (yes)	no
Option 3	Entrance time (10 or 20 seconds)	time input. 10	20
Option 4	Pre-alarm during entrance time	preal. input. no	si (yes)
Option 5	Alarm time (90 or 180 seconds)	time alarm 90	180
Option 6	Alarm cycles for line cut-off	auto off si (yes)	no
Option 7	Silent or audible hold-up	hold-up silen	siren
Option 8	Arming with open zone	On forced no	si (yes)

ATTENTION Exit time is fixed at 30 seconds (not programmable).

■ **To proceed to next option:**

- Press button "A" on front panel.

PROG OPTION
code 34 bits



PROG OPTION
siren rf si (yes)

■ **To modify the option memorized:**

- Press button "B" on front panel.

PROG OPTION
time input 10



PROG OPTION
time input 20

To proceed to the next phase of programming:

Keep button "A" pressed and press button "B" once.



ATTENTION You may not exit the programming mode in this phase.
To exit programming mode, you must complete all 5 phases.

ENGLISH

12.2. 2nd PHASE - SELF LEARNING OF ELECTRONIC KEY and KEYPAD

With 34 bit the control panel can learn eight different codes of electronic keys and/or remote keypads.
For every code an unlimited amount of keys or keypads may be used.

PROG KEY
ch. n. 1 : no

As soon as you enter in the 2nd phase, the display signals if the 1st position is already occupied or not. Therefore, one of the 2 messages on the right will appear on the display.

PROG KEY
ch. n. 1 : si (yes)

During the time of this 2nd phase the LED "LOW B." (on the panel and Digit-KD) will light, while the LED "TEST" (on the Digit-KD) will flash quickly.

Procedure for self learning code:

- 1) If the position 1 is free, insert an electronic key into receptacle on the panel or the remote position, or digit the "access code" and then "#" on the Digit-KD.
- 2) The control panel will confirm code learned by sounding of **one beep**. On the display of the control panel and Digit-KD appears the message on the right.
- 3) If the panel emits the **beep**, but the display does not show the message that confirms the code has been learned, this means that the code is already stored in memory, but in another location. So, use another key or digit a new code on the Digit-KD and repeat operations 1) and 2).
- 4) By pressing the button "B" on the panel, the code learned will be cancelled and position 1 becomes free.
- 5) To go to the next position, press the button "A" on the panel and repeat operations 1), 2), 3) and 4) and so on up to position 8.

PROG KEY
ch. n. 1 : no

PROG KEY
ch. n. 1 : si (yes)

PROG KEY
ch. n. 1 : no

PROG KEY
ch. n. 1 : si (yes)



PROG KEY
ch. n. 1 : no



PROG KEY
ch. n. 2 : no

To proceed to next phase of programming:

Keep button "A" pressed and press button "B" once.



ATTENTION

You may not exit the programming mode in this phase.
To exit programming mode, you must complete all 5 phases.

12.3. 3rd Phase - ZONE PROGRAMMING L1→L8 (N.C. or BALANCED)

As soon as you enter the 3rd programming phase, the display shows how the first zone has been programmed: balanced or normally closed (NC).

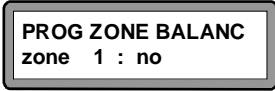

During the 3rd phase, the LED "LOW B." (on the panel and Digit-KD) and the LED "TEST" (on the Digit-KD) will flash quickly.

Each of 8 zones may be programmed as **normally closed (NC)**, or **double balance balanced** (see paragraph 6.1.).

ATTENTION *The control panel is factory set for zone L1 → L8 are all N.C.*

■ **Visualization of the memorized configuration:**

- If the zone is normally closed (NC), on the display will appear the message on the right.
- If the zone is balanced, on the display will appear the message on the right.

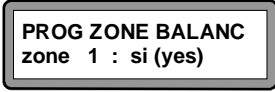
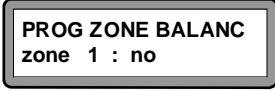

■ **To modify the memorized configuration:**

- Press button "B" on front panel. (see on the right).

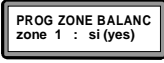
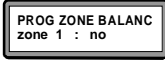

■ **To proceed to next zone:**

- Press button "A" on front panel. (see on the right).

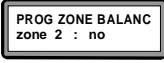
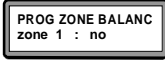

To proceed to next phase of programming:
Keep button "A" pressed and press button "B" once.



ATTENTION You may not exit the programming mode in this phase. To exit the programming mode, you must complete all 5 phases.

ENGLISH

12.4. 4th Phase - IMMEDIATE / DELAYED ZONES CONFIGURATION

As soon as you enter the 4th programming phase, the display shows how the first zone has been programmed: immediate or delayed.

PROG ZONE DELAY
zone 1 : si (yes)

During the 4th phase, the LEDs "TAMPER" and "TEST" (both on the Digit-KD) will flash quickly.

Each of 8 zones may be programmed as **immediate** or **delayed** (with entrance time 10 or 20 seconds - see option 3 in the paragraph 12.1.).

ATTENTION *The control panel is factory set for zone L1 → L8 are all immediate.*

■ **Visualization of the memorized configuration:**

- If the zone is delayed, on the display will appear the message on the right.
- If the zone is immediate, on the display will appear the message on the right.

PROG ZONE DELAY
zone 1 : si (yes)

PROG ZONE DELAY
zone 1 : no

■ **To modify the memorized configuration:**

- Press button "B" on front panel.
(see on the right).

PROG ZONE DELAY
zone 1 : si (yes)



PROG ZONE DELAY
zone 1 : no

■ **To proceed to next zone:**

- Press button "A" on front panel.
(see on the right).

PROG ZONE DELAY
zone 1 : no



PROG ZONE DELAY
zone 2 : no

To proceed to next phase of programming:

Keep button "A" pressed and press button "B" once.



ATTENTION

**You may not exit the programming mode in this phase.
To exit programming mode, you must complete all 5 phases.**

12.5. 5th Phase - GROUPING UP ZONES FOR DAY / NIGHT ARMING

Besides the normal zone by-passing (see paragraph 19.0.), each zone may be associated to a group of zones called **NIGHT**. This allows the end user to partially arm the system (**NIGHT mode**). By so doing, all zones set for **NIGHT mode** are by-passed.

All zones not set for Night mode are automatically set for **DAY mode**.

When you enter the 5th programming phase, the display shows how the first zone has been programmed.

PROG ZONE NIGHT
zone 1 : no

During the 5th phase the LEDs "FIRE" and "TEST" (both on the Digit-KD) will flash quickly.

ATTENTION *The control panel is factory set for zone L1 → L8 all in Day.*

■ **Visualization of the memorized configuration:**

- If the zone does not belong to Night group, on the display will appear the message on the right.
- If the zone belongs to Night group, on the display will appear the message on the right.

PROG ZONE NIGHT
zone 1 : no

PROG ZONE NIGHT
zone 1 : si (yes)

■ **To modify the memorized configuration:**

- Press button "B" on front panel. (see on the right).

PROG ZONE NIGHT
zone 1 : no



PROG ZONE NIGHT
zone 1 : si (yes)

■ **To proceed to next zone:**

- Press button "A" on front panel. (see on the right).

PROG ZONE NIGHT
zone 1 : no



PROG ZONE NIGHT
zone 2 : no

12.6. EXITING THE PROGRAMMING MODE

During or after the 5th phase, it is possible to exit programming mode by keeping button "A" always pressed and press once button "B".

The control panel will exit programming mode and go into Maintenance mode (the "TEST" LED will flash slowly on the remote keypad).



ENGLISH

13.0. RETURNING FACTORY SETTING

Returning to factory setting causes:

- 1) **Cancellation of all electronic keys and remote keypads memorized.**
- 2) **All zones (L1 → L8) become Immediate, "Normally Closed" and all "DAY".**
- 3) **All options return to factory programming:**

Option 1	- Electronic key code	34 bit
Option 2	- Siren rf	si (yes)
Option 3	- Time input	10 sec.
Option 4	- Preal input	Silent
Option 5	- Time alarm	90 sec.
Option 6	- Auto off after 4 alarm cycles	si (yes)
Option 7	- Hold-up	Silen
Option 8	- On forced	No

■ **To activate factory program:**

With the panel in Maintenance mode, press the button "B" for 5 sec.

This will cause:



- The emission of a beep.
- Lighting of the LEDs "LOW B." (on the panel and Digit-KD), "TAMPER" and "FIRE" (both on the Digit-KD) for a few seconds and flashing quickly of LED "TEST" (on the Digit-KD).
- For a few seconds on the display of the control panel and Digit-KD will appear the message on the right.
- At the end of above process, the panel will return to Maintenance mode indicated by slow flashing of LED "TEST" on the Digit-KD.

FTY DEFAULTS

**MAINT
OK**

ATTENTION *Exit time is fixed at 30 seconds.*

14.0. TOTAL ARMING (Day mode)

■ **Procedure:**

- With the control panel disarmed (OFF), proceed as following:
 - Insert a memorized electronic key into receptacle on the panel or remote position.
 - Or digit the "access code" and then "#" on the Digit-KD.



- The control panel will emit a beep. On the display of the control panel and Digit KD appears the message on the right.



- After a few seconds will appear the message "delay". This triggers the **exit time** counter for a **30 seconds**.

■ **During the exit time the following will take place:**

- The message "ON" (on the display of the control panel and Digit-KD) and the LED "ON" (on the panel, electronic key receptacle and Digit-KD) will **flash quickly**.
- If however there are open or unbalanced lines not by-passed, or control panel has low battery, the message "ON" on the display and the LED "ON" will **flash slowly**. Furthermore, on the display appears the message "zone in alarm" or "battery centr."

- If a few zones are by-passed, on the display appears the message "zone by-p" instead of "delay". To verify the zones by-passed, press more times the buttons ▲ ▼ on the panel, or the keys [] [] on the Digit-KD. On the display the menu (in groups of 4) are visualized with the complete list of the 8 zones, plus **Bat** (low battery), **Tmp** (tamper) and **Firendio** (fire). Beside the excluded zones a dot will appear that **flashes quickly**. This indicate that the zone is by-passed.

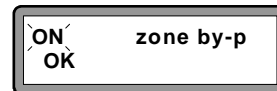

- If one or more zones are by-passed, the "Alarm memory" LED on the electronic key receptacle will **flash slowly**.

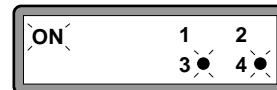

In the above example the zones 3 and 4 are by-passed

■ **At the end of the exit time:**

- The message "ON" (on the display of the control panel and Digit-KD) and the LED "ON" (on the panel, electronic key receptacle and Digit-KD) will **light up**.
- The messages "delay" or "zone by-p" on the display and the signalling of the by-passed zones (seen by looking through the menu) and the "Alarm Memory" LED on the electronic key receptacle will **go off**.
- The panel is now armed in **Day** mode and in function based on how it is programmed.

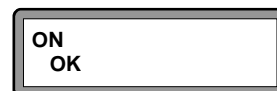

ATTENTION If, when the control panel is armed, there is an open or unbalanced zone, or control panel has low battery and "option 8" is still factory set, **the control panel will not arm.**

ENGLISH

1) **The unbalancing of the 24 hour, fire and hold-up zones, the tampering of the control panel and hardwire sensors installed on the zones L1 → L8 programmed as double balanced, or insertion of a false electronic key and low battery will provoke** a state of alarm through a volt free relay as indicated in points 1), 2), 3), 4) and 5) of Page 27 and 28.

2) **By opening or unbalancing any of the zones L1 → L8 will cause:**

- **Slow flashing** on the display of the message related to the zone in alarm (if the zone is immediate).
In the example on the right, "zone 5" is in alarm.
The message will be visualized until the control panel is re-armed.



If the zone is delayed, the message "**delay alarm**" will appear on the display during the entrance time (see on the right), followed by the message corresponding to the zone in alarm which will **flash slowly** until the control panel is re-armed.





- The sound for the alarm time programmed of the incorporated buzzer (if the zone is immediate).
If the line is delayed and pre-alarm is activated, an acoustic intermittent signal will take place during the entrance time (pre-alarm). After pre-alarm, the acoustic signal becomes continuous until the zone triggered has returned to normal.
- The activation for 30 or 60 seconds of the output for the telephone dialler (Terminal 44).
- The activation for the alarm time programmed of the recyclable and not recyclable alarm relays (Terminals from 18 to 25) .
- The lighting of the "**Alarm memory**" LED on the electronic key receptacle until the control panel is re-armed.

15.0. PARTIAL ARMING (Night mode)







All zones that belong to the group "Night" are excluded during arming (see paragraph 12.5.).

■ **Procedure:**

- With the control panel disarmed (OFF), proceed as follows:
 - Insert a memorized electronic key into receptacle on the panel or remote position and **leave it inserted for at least 3 seconds.**
 - Or digit the "access code" and then "#" on the Digit-KD and after the message "delay", press the button  on the Digit-KD.
- The control panel will emit a beep and on the display will appear the symbol  flashing.
- From the moment that the message "delay" appears, the **exit time of 30 seconds** begins.



■ **During the exit time the following will take place:**

- The **green** LED on the electronic key receptacle will light to signal control panel armed **Night mode.**
- The message "ON" and the symbol  (on the display of control panel and Digit-KD) and the LED "ON" (on the panel, electronic key receptacle and Digit-KD) will **flash quickly.**
- If however there are open or unbalanced lines not by-passed and not associated to the Night group, or control panel has low battery, the message "ON" and the symbol  (on the display) and the LED "ON" (on the panel, electronic key receptacle and Digit-KD) will **flash slowly.**
Furthermore, on the display appears the message "zone in alarm" or "battery centr."
- If a few zones are by-passed and if a few zones are associated to the Night group, on the display appears the message "zone by-p" instead of "delay".
To verify the zones by-passed or associated to the Night group, press more times the buttons   on the panel, or the keys   on the Digit-KD.
On the display, the menu (in groups of 4) are visualized with the complete list of the 8 zones, plus **Bat** (low battery), **Tmp** (tamper) and **Firendio** (fire). Beside the excluded zones or associated to the Night group a dot will appear that **flashes quickly.**
- If one or more zones are by-passed or associated to the Night group, the "Alarm memory" LED on the electronic key receptacle will **flash slowly.**

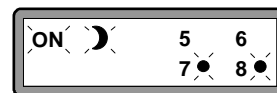
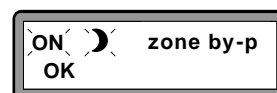

In the above example the zones 7 and 8 are associated to the Night group

ENGLISH

■ At the end of the exit time:

- The message "ON" and the symbol ☾ (on the display of control panel and Digit-KD) and the LED "ON" (on the panel, electronic key receptacle and Digit-KD) will **light up**.
- The messages "delay" or "zone by-p", indication of the zones by-passed or zones associated to the Night group (seen by looking through the menu), the "Alarm Memory" LED and the green LED (on the electronic key receptacle) will **go off**.
- The panel is now armed in **Night** mode and in function based on how it is programmed.



ATTENTION

If, when the control panel is armed, there is a triggered or unbalanced zone, or control panel has low battery and "option 8" is still factory set, the control panel will not arm.

With regards to zone violation, please see points 1) and 2) on Page 22.

16.0. ARMING TEST-CONTROL (Day mode)

Activation of this function allows you to arm in Day mode and test the installation without triggering the alarm relays. All alarms triggered are indicated by an acoustic signal emitted through the incorporated buzzer.

ATTENTION

With the panel armed in Test-Control mode (Day and Night), all by-passed zones are armed, but the automatic zone cut-off feature after 4 alarm cycles is not active.

■ Procedure:

- With the control panel disarmed (OFF), proceed as following:
 - Insert a memorized electronic key into receptacle on the panel and before that on the display shows "delay", press the button "B" on the panel.
 - Or digit the "access code" and then "#" on the remote keypad and, before the display shows "delay", press the button Ⓚ on the Digit-KD.
- The control panel will emit a beep and on the display will appear the message on the right.
- The LED "TEST" on the Digit-KD will light until the control panel is disarmed.
- From the moment that the message "delay" appears, the **exit time** of **60 seconds** begins.



■ **During the exit time the following will take place:**

- The LED "ON" (on the panel, electronic key receptacle and Digit-KD) and the message "TEST" (on the display of the control panel and Digit-KD) will **flash quickly**.
- If however there are zones triggered or unbalanced not by-passed, or control panel has low battery, the LED "ON" and the message "TEST" will **flash slowly**.
- If zones are by-passed, on the display appears the message "zone by-p" instead of "delay".
To verify the zones by-passed, press more times the buttons ▲ ▼ on the panel, or the keys [] [] on the Digit-KD. On the display the menu (in groups of 4) are visualized showing the complete list of the 8 zones, plus **Bat** (low battery), **Tmp** (tamper) and **Firendio** (fire). The zones by-passed are indicated with a dot that **flashes quickly**.
- If one or more zones are by-passed, the "Alarm memory" LED on the electronic key receptacle will **flash slowly**.

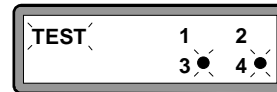
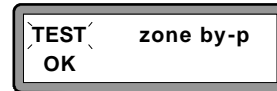

In the above example the zones 3 and 4 are by-passed

■ **At the end of the exit time:**

- The LED "ON" (on the panel, electronic key receptacle and Digit-KD) and the message "TEST" (on the display of the control panel and Digit-KD) will **light up**.
- The messages "delay" or "zone by-p" on the display and the indications of the by-passed zones (seen by looking through the menu) and the "Alarm Memory" LED on the electronic key receptacle will **go off**.
- The control panel is armed in "Test-Control Day mode".



1) **Even if the control panel is in Test-Control mode, the unbalancing of the 24 hour lines, fire and hold-up, tampering of the control panel and of hardwire sensors installed on the L1 → L8 lines programmed as double balanced, insertion of a false electronic key and low battery will trigger a state of alarm through a volt free relay in the same way indicated on the points 1), 2), 3), 4) and 5) of Page 27 and 28.**

2) **By triggering or unbalancing of one of the zones L1 → L8 will cause:**

- **Slow flashing** on the display of the message related to the zone in alarm (if the zone is immediate).
In the example on the right, the "zone 3" is in alarm.
The message will be visualized until the control panel is re-armed.
If the zone is delayed, the message "delay alarm" will appear on the display during the entrance time (see on the right), afterwards on the display the message corresponding to the zone in alarm will **flash slowly** until the control panel is re-armed.
- Sounding of the internal beeper while the immediate line is triggered.
 - If the line is delayed and the pre-alarm during entrance time is set to silent, at the end of the entrance time a long beep every 10 seconds will be emitted until the line returns to normal.
 - If the line is delayed and the pre-alarm during entrance time is set to audible, a short beep every second will be emitted during the entrance time until the open line returns to normal.
- The lighting of the "Alarm memory" LED on the electronic key receptacle until the control panel is re-armed.



ENGLISH



17.0. ARMING TEST-CONTROL (Night mode)

Activation of this function allows you to arm in Night mode and test the installation without triggering the alarm relays. The alarms are signalled by acoustic signals emitted through the incorporated buzzer.

ATTENTION







With the panel in Test-Control mode (Day and Night), all the by-passed zones are active, but automatic cut-off feature after 4 alarm cycles is not active.

■ Procedure:

- With the control panel disarmed (OFF), proceed as following:
 - Insert an electronic key in the receptacle on the panel and **leave it inserted for at least 3 seconds** and, before the message "delay" appears, push the button "B" on the panel.
 - Or digit the "access code" and then "#" on the Digit-KD and, before the message "delay" on the display appears, press the key  on the Digit-KD.
After "delay" is shown, press again the key .
- The control panel will emit a beep and on the display will appear the message on the right.
- The LED "TEST" on the Digit-KD will light until the control panel is disarmed.
- From the moment that the message "delay" appears, the **exit time** of **60 seconds** begins.



■ During the exit time the following will take place:

- The **green** LED on the electronic key receptacle will light to signal control panel armed **Night** mode.
- The message "TEST" and the symbol  (on the control panel and Digit-KD) and the LED "ON" (on the panel, electronic key receptacle and Digit-KD) will **flash quickly**.
- If however there are lines open or unbalanced not by-passed and not associated to the Night group, or control panel has low battery, the message "ON" and the symbol  (on the display) and the LED "ON" (on the panel, electronic key receptacle and Digit-KD) will **flash slowly**.
- If a few zones are by-passed and if a few zones are associated to the Night group, on the display appears the message "zone by-p" instead of "delay".
To verify the zones by-passed or associated to the Night group, press more times the buttons   on the panel, or the keys   on the Digit-KD.
On the display the menu (in groups of 4) are visualized showing the complete list of the 8 zones, plus **Bat** (low battery), **Tmp** (tamper) and **Firendio** (fire). Beside the excluded zones or associated to the Night group a dot will appear that **flashes quickly** (see on the right).
- If one or more zones are by-passed or associated to the Night group, the "Alarm memory" LED on the electronic key receptacle will **flash slowly**.

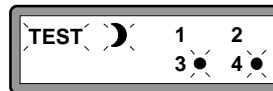

■ At the end of the exit time:

- The message "TEST" and the symbol  (on the control panel and Digit-KD) and the LED "ON" (on the panel, electronic key receptacle and Digit-KD) will **light up**.
- The messages "delay" or "zone by-p", indication of the by-passed zones or zones associated to the Night group can be seen by looking through the menu, the "Alarm Memory" LED and the green LED (on the electronic key receptacle) will **go off**.
- The control panel is armed in "Test-Control Night mode".



With regards to zone violation, please see points 1) and 2) on Page 25.

18.0. DISARMING

■ **Procedure:**

- With the control panel armed in Day, Night or Test-Control mode proceed as follows:
 - Insert a memorized electronic key into receptacle on the panel or remote position.
 - Or digit the "access code" and then press "#" on the Digit-KD.

- **The control panel emits 2 beeps and will disarm.**
The LED "ON" (on the panel, on the electronic key receptacle and on the remote keypad) will go off. On the display will appear the message on the right.

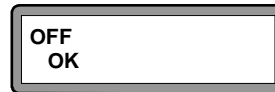

- If during arming mode alarms have been triggered, "Alarm Memory" will activate until the control panel is re-armed.

On the display of the control panel and Digit-KD, the zone in which the alarm has taken place will **flash slowly**.

In the example on the right, "zone 3" has been triggered.



1) The unbalancing of the 24 hour line (Terminals 11 and 12), the tampering of the control panel and of the sensors installed on zones L1 → L8 configured as double balanced and the inserting of false electronic keys will cause:

- The activation of recyclable and non recyclable alarm relays (Terminals from 18 to 25) for the alarm time programmed.
- The sound of the incorporated buzzer for the programmed alarm time.
- The activation for 30 or 60 seconds of the output for the telephone dialler (Terminal 44).

- **Slow flashing** of the message "tamper wire" on the display of the control panel and Digit-KD.

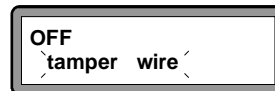

- **Slow flashing** of "TAMPER" LED on the Digit-KD and the **lighting** of the "Alarm Memory" LED on the electronic key receptacle.

- The message and the LEDs will remain active until the control panel is re-armed.

2) The unbalancing of the fire line (Terminals 12 and 13) will cause:

- The activation of the fire alarm relay (Terminals 5, 6 and 7) for 30 or 60 seconds.
- The activation of recyclable and non recyclable alarm relays (Terminals from 18 to 25) for the alarm time programmed.
- The sound of the incorporated buzzer for the programmed alarm time.

- **Slow flashing** of the message "fire wire" on the display of the control panel and Digit-KD.

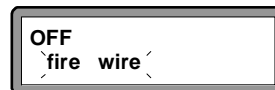

- **Slow flashing** of "FIRE" LED sulla Digit-KD on the Digit-KD and the **lighting** of the "Alarm Memory" LED on the electronic key receptacle.

- The message and the LEDs will remain active until the control panel is re-armed".

ENGLISH

3) The unbalancing of the panic line (Terminals 14 and 15) will cause:

- The activation of the panic alarm relay (Terminals 8, 9 and 10) for 30 or 60 seconds. (audible and non audible panic).
- The activation of recyclable and non recyclable alarm relays (Terminals from 18 to 25) for the alarm time programmed (**only audible panic**).
- The sound of the incorporated buzzer for the programmed alarm time (**only audible panic**).
- **Slow flashing** of the message "hold-up wire" on the display of the control panel and Digit-KD.
- **Slow flashing** of "TAMPER" LED on the Digit-KD and the **lighting** of the "Alarm Memory" LED on the electronic key receptacle.
- The message and the LEDs will remain active until the control panel is re-armed.

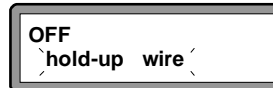

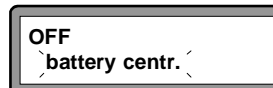

4) Low battery level of the control panel (load under 10.5 V) will cause:

- The sound of the incorporated buzzer for the programmed alarm time.
- The activation for 30 or 60 seconds of the output for the telephone dialler (Terminal 43).
- **Slow flashing** of the message "battery centr." on the display of the control panel and Digit-KD.
- **Slow flashing** of "LOW B." LED on the panel and Digit-KD and the **lighting** of the "Alarm Memory" LED on the electronic key receptacle.
- The message and the LEDs will remain active until the control panel is re-armed even if the battery has, in the meantime, been changed.



5) Triggering L1 → L8 when functioning in N.C. or the unbalancing of the zone functioning with double balanced connection (both not by-passed) will cause:

- On the Digit-KD will appear the message "zone in alarm" for the entire time that the line remains open or unbalanced.
To verify which are the zones in alarm, press more times the buttons ▲ ▼ on the panel, or the keys   on the Digit-KD.
On the display the menu (in groups of 4) are visualized with the complete list of the 8 zones, plus **Bat** (low battery), **Tmp** (tamper) and **Firendio** (fire).
Beside the triggered zones a dot that **flashes slowly** will appear (see example on the right).

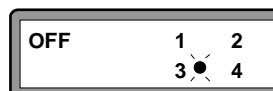

In the above example the "zone 3" is in alarm

19.0. BY-PASSING ZONES

This operation must be carried out with the **control panel disarmed** and can be done with the electronic key on the panel (and the "A" button) and with remote keypad Digit-KD.

NOTE: The anti-tamper, fire and panic zones (Terminals 11➔15) can not be by-passed.

1) To enter into by-passing mode:

- With the control panel disarmed (OFF), proceed as following:
 - Insert an electronic key in the receptacle on the panel and, before the message "delay" on the display appears, push the button "A" on the panel.
 - Or, digit the "access code", push the "#" key and, before the message "delay" on the display appears, push the key  on the Digit-KD.

- The control panel will emit a beep and enter into "By-passing mode". During the by-passing time the LED "TEST" is lit on the Digit-KD. On the display of the control panel and Digit-KD is visualized the configuration of the 1st zone.

- If the zone is **not by-passed**, the message on the right will appear.

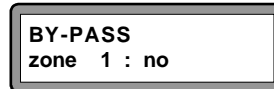

- If the zone is **by-passed**, the message on the right will appear.

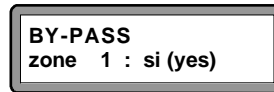

2) To modify the zone status:

- Press the button "B" on the panel.
- Or press the key  on the Digit-KD.
- The "zone 1" passes from armed to by-passed or vice-versa.

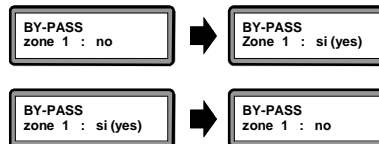



3) To proceed to the next zone:

- Press the button "A" on the panel.
- Or press the key  on the Digit-KD.
- From "zone 1" pass to "zone 2" and so on until zone 8. To modify the status of "zone 2" and following zones, proceed as point 2).



ENGLISH

If a zones are by-passed, on the display will appear the message “**zone by-p**” during the exit time (before the control panel is armed.)

To verify which are the zones by-passed, press more times the buttons ▲ ▼ on the panel, or the keys   on the Digit-KD.

On the display the menu (in groups of 4) are visualized with the complete list of the 8 zones, plus **Bat** (low battery), **Tmp** (tamper) and **Firendio** (fire).

Beside the by-passed zones a dot will appear that **flashes quickly**.

Moreover, in presence of by-passed zones, the LED “**Alarm memory**” on the electronic key receptacle **flashes slowly** during the exit time. After this time the LED will go off.

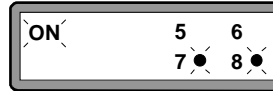

In the above example the zones 7 and 8 are by-passed

ATTENTION

The by-passed zones cannot be visualized when the control panel is in Maintenance mode.

ATTENTION

Even if a zone is by-passed, the tamper alarm will always be in function.

19.1. EXITING BY-PASSING MODE

- Keep button “**A**” pressed and press button “**B**” more times until the message that indicates control panel disarmed (OFF) will appear on the display (see the message on the right).
- Or, insert more times a programmed key on the receptacle on the panel until the message that indicates control panel disarmed (OFF) will appear on the display.
- Or, if you entered by-pass mode using the Digit-KD, press more times the key “**#**” on the remote keypad until the message that indicates control panel disarmed (OFF) will appear on the display.



The “**TEST**” LED on the Digit-KD will go off.

20.0. HOLD-UP FUNCTION

The hold-up function can be activated unbalancing the **always active** panic zone (Terminals 14 and 15).

With the control panel armed or disarmed, the unbalancing of the line will provoke:

- On the Digit-KD the **"TAMPER"** LED will **flash slowly** and on the electronic key receptacle the **"Alarm Memory"** LED will light.
Both the LEDs will remain active until the control panel is re-armed.
- On the display the message **"hold-up wire"** will appear that **flashes slowly**. The message will remain visualized until the control panel is re-armed.
- If **silent panic** is selected, the unbalancing of the line provokes the activation of only the panic alarm relay (Terminals 8, 9 and 10) for 30 or 60 seconds.
- If however **audible panic** is selected, the unbalancing of the line provokes not only the activation of the panic alarm relay for 30 or 60 seconds, but also the activation of the recyclable and non recyclable alarm relays (Terminals from 18 to 25) and the sounding of the incorporated buzzer for the time programmed.

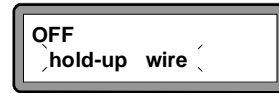

20.1. RESET HOLD-UP FUNCTION

- To reset a hold-up alarm, proceed as following:
 - Insert an electronic key in the receptacle on the panel or remote position.
 - Or digit the **"access code"** and then the **"#"** key on the Digit-KD.
- If the hold-up function has been activated while the control panel is disarmed, the hold-up alarm reset will provoke only the deactivation of the panic alarm relay and incorporated buzzer.
The VISION 8 will remain disarmed and the "Alarm memory" will remain visualized until the control panel is re-armed.
- If the hold-up function has been activated while the control panel is armed, the hold-up alarm reset will provoke, in addition to the deactivation of the panic alarm relay and incorporated buzzer, also the disarming of the VISION 8.
The "Alarm memory" will remain visualized until the control panel is re-armed.

ENGLISH

21.0. ALARMS PRIORITY ORDER

The alarms are triggered based on the following priority:

Priority	ALARM TYPE	ALARM PROCEDURE
1	Hold-up alarm	Alarm cycle based on paragraph 23.0.
2	Fire alarm	Alarm cycle based on paragraph 23.0.
3	Tamper alarm	Alarm cycle based on paragraph 23.0.
4	Alarm immediate zone	Alarm cycle based on paragraph 23.0.
5	Alarm delay zone	Alarm cycle based on paragraph 23.0.
6	Low battery	Alarm cycle based on paragraph 23.0.

- A low priority alarm (ex: low battery), will be interrupted by a higher priority alarm (ex: an immediate alarm).
- If an alarm is triggered on a delay zone and during the exit time you have an alarm also on the immediate zone, the exit time is no longer taken into consideration and only the immediate alarm is triggered.
- If during the exit time there are 2 alarms on the same delay zone, only the first alarm will be memorized.
- When the panel is in alarm status, it will not memorize any other alarm trigger.

NOTE: The order of priority is valid even with the panel is armed in Test-Control (Day and Night mode).

22.0. RECYCLABLE AND NON RECYCLABLE ALARM

The VISION 8 has 4 alarm relays:

- 1) **Fire alarm relay** (Terminals 5, 6, 7)
Triggered only if there is a fire alarm.
Alarm activation time: 30 or 60 seconds per cycle (see paragraph 23.0).
- 2) **Hold-up alarm relay** (Terminals 8, 9, 10)
Triggered only if there is a hold-up alarm (audible or silent).
Alarm activation time: 30 or 60 seconds per cycle (see paragraph 23.0).
- 3) **Recyclable alarm relay** (Terminals 18, 19, 20, 21, 22)
Triggered if there is a burglary, fire, tamper and audible hold-up alarm.
Alarm activation time: 90 or 180 seconds per cycle (see option 5 of paragraph 13.1.) with alarm procedure described on paragraph 23.0.
- 4) **Non recyclable alarm relay** (Terminals 23, 24, 25)
Triggered if there is a burglary, fire, tamper and audible hold-up alarm.
Alarm activation time: 90 or 180 seconds per cycle (see option 5 of paragraph 13.1.) with alarm procedure described on paragraph 23.0.

■ **Recyclable alarm**

- If at the end of the alarm cycle the zone is no longer triggered, the relay will deactivate.
- If, however, at the end of the alarm cycle the zone is still triggered or unbalanced, another alarm cycle will take place as the previous one and will continue this way until the zone is normalized.
- **If the above takes place 4 consecutive times, the zone will be automatically excluded** (see paragraph 24.0).
This takes place if option 6 (see paragraph 13.1.) is in function.
- The "Alarm memory" LED on the electronic key receptacle will **light up** and will remain lit until the control panel is re-armed.

■ **Alarm not recyclable**

- At the end of the alarm cycle, the non recyclable alarm relay **will deactivate** regardless of the state of the line and **remain deactivated for 30 minutes disregarding all alarms of the same type**.
- If however, there is a different alarm situation, or more than 30 minutes has gone by since the previous alarm, the relay will trigger again.

ENGLISH

23.0. ALARM PROCEDURE

During the programming mode it is possible to enter 2 different alarm times: 90 or 180 seconds.

This is valid only for the **recyclable alarm** relay (Terminals 18,19,20,21,22), **non recyclable alarm** relay (Terminals 23,24,25) and for the incorporated buzzer, while the **fire alarm** (Terminals 5,6,7), the **panic alarm** (Terminals 8,9,10) and the **negative output** (Terminals 43,44) will active only for **30** seconds (if an alarm time of 90 seconds has been selected) or **60** seconds (if an alarm time of 180 seconds has been selected).

You must consider that the recyclable and non recyclable alarm relays do not remain triggered continuously for 90 or 180 seconds, there is a 3 second pause between triggers as shown below:

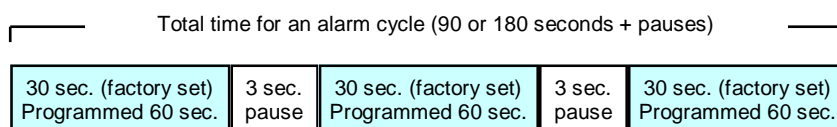

From the above, you will notice that the full alarm time in the case of a 90 second alarm is $30+3+30+3+30=96$ seconds before another alarm can be triggered and, in the case of 180 seconds alarm, the total time will be 186 seconds.

Activations	PANIC Alarm	FIRE Alarm	TAMPER Alarm	BURGLARY Alarm	LOW BATTERY
Recyclable alarm relay	YES (audible panic)	YES	YES	YES	
Non recyclable alarm relay	YES (audible panic)	YES	YES	YES	
Fire alarm relay		YES			
Panic alarm relay	YES				
Incorporated buzzer	YES (audible panic)	YES	YES	YES	YES
Negative output for low battery					YES
Negative output for burglary and tamper alarm			YES	YES	

ATTENTION

With the **control panel disarmed**, to interrupt an alarm, insert a memorized electronic key into receptacle on the panel or remote position, or digit the "access code" and then "#" on the Digit-KD.

This will shut down the alarm and leave the control panel disarmed. If the cause of the alarm still exists, another alarm cycle will be triggered after 10 seconds.

With the **control panel armed**, an alarm interruption will cause the control panel to disarm.

24.0. AUTOMATIC ZONE EXCLUSION

In the case of repeated alarms generated by the same cause (ex: a sensor non functioning correctly), the control panel activates a system of automatic zone exclusion. This function can be deactivated.



NOTE This function may be applied in the case of burglary, fire, tamper and audible hold-up alarms.

■ **The zone is automatically excluded if:**

- An alarm is triggered.
- The alarm activates the relays with the procedure shown in paragraph 23.0.
- This event repeats itself 4 consecutive times on the same zone.

■ **Signalling of an automatically excluded zone:**

- If while arming the control panel alarms have been triggered, when the control panel is disarmed the display will show the last event and **flash slowly until the panel is re-armed.**

To verify the alarms triggered, press more times the buttons ▲ ▼ on the panel, or the keys   on the Digit-KD.

On the display the menu (in groups of 4) is visualized showing the complete list of the 8 zones, plus **Bat** (low battery), **Tmp** (tamper) and **Firendio (fire)**.

Beside the automatically excluded zones a dot will appear **flashing quickly** (see example on right).

This signal has priority on the "Alarm memory".

- The "Alarm memory" LED on the electronic key receptacle will light.

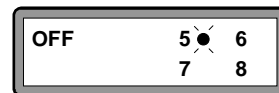



In the above example the "zone 5" is excluded

- **The zones that are automatically cut-off will remain as such after the control panel has been disarmed, but will become active again when the control panel is re-armed.**
- **The zone cut-off system will not function if the control panel is armed in "Test-control" (Day and Night).**
- **All alarms generated by excluded zones are ignored.**
- An alarm caused by "Low battery" will trigger only Terminal 43 normally used for automatic telephone diallers.
- A "Low battery" alarm will interrupt the automatic exclusion process.
- It is not possible to automatically exclude low priority alarms.
- The double balanced zones that can distinguish the alarm from the tamper, will have automatic cut-off after 4 consecutive triggers of the same type (alarm or tamper).
- If the zone is cut-off for tamper, the "TAMPER" LED on the Digit-KD will flash quickly.

ENGLISH

25.0. ALARM MEMORY

- Each alarm which triggers a relay output and therefore a siren will be indicated in the **"Alarm memory"**.
- In Test-Control mode, the incorporated buzzer will take the siren's place.
- If the zone is delayed, the **"Alarm memory"** will activate at the end of entrance time.
- If during entrance time a higher priority alarm is triggered, the previous alarm will not be memorized.
- The memorized alarms are indicated by the **slow flashing** on the display of the message corresponding the last event triggered until the control panel is re-armed.
By pressing more times the buttons ▲ ▼ on the panel, or the keys   on the Digit-KD, the display will visualize (in groups of 4) the menus with the complete list of the 8 zones, plus **Bat** (low battery), **Tmp** (tamper) and **Firendio (fire)**.

Beside the triggered zones, a dot will appear that **flash-es slowly** (see example on the right).

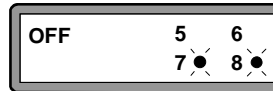

In the above example the zone 7 and 8 signal alarm memory

- In the presence of at least one alarm, the **"Alarm memory"** LED on the electronic key receptacle **will light**.
- The **"Alarm memory"** has the priority on the alarm signalling (tamper, burglary, fire, hold-up and low battery).
- The **"Alarm memory"** will remain even after the control panel is disarmed and will be cancelled only when the VISION 8 is re-armed.

26.0. LOW BATTERY

In the case of mains failure, the power is supplied by the internal battery.
When the battery voltage reaches 10.5 V, the panel will signal the event by:

● **In Maintenance**

- The message "battery centr." on the display will appear.
- The "LOW BAT." LED on the panel and Digit-KD will light.



● **With the control panel disarmed and armed** (Day, Night and Test-Control mode)

- The **slow flashing** of the message "battery centr." on the panel and Digit-KD until the control panel is re-armed.
- The **slow flashing** of the "LOW B." LED on the panel and Digit-KD and the **lighting** of the "Alarm memory" LED on the remote electronic key receptacle.
The LEDs will remain active until the control panel is re-armed.
- The activation for 30 or 60 seconds of the output for the telephone dialler (Terminal 43).
- The sounding of the buzzer for the programmed time.
To reset the buzzer digit the "access code" and then "#" on the Digit-KD, or insert a memorized electronic key into remote receptacle.

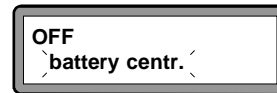

- If the "Low battery" alarm has already been memorized, it will remain memorized until the memory is reset (for example when the control panel is re-armed).
- If "Low battery" signalling continues, check if the mains is present (green LED "POWER" lit), check the mains fuse and if the battery charger is functioning correctly (+13.8 Vdc on

ENGLISH

27.0. TECHNICAL CHARACTERISTICS

- Power: 230 Vca - 50 / 60 Hz
- Current drain in maintenance: 65 mA
- Current drain with panel disarmed: 70 mA
- Current drain with panel armed: 100 mA
- Alarm time: 90 or 180 seconds (programmable)
- Entrance time: 10 or 20 seconds (programmable)
- Exit time: 30 seconds (fixed)
- Activation time of fire and hold-up relays and of telephone diallers outputs (Terminals 43 and 44): 30 or 60 seconds
- Free volt relay contacts panic alarm: 1 A max
- Free volt relay contacts fire alarm: 8 A max
- Free volt relay contacts recyclable and non recyclable alarm: 8 A max
- SMD technology
- Rechargeable battery housing: 12 V - 17 Ah max
- Dimensions: 310x315x80 mm
- Weight: 4,9 Kg



Do not litter. Separate and discard the packaging materials in the containers (depending on the rules in force at the place of residence).



Do not litter. Turn the device and the batteries over to a designated disposal at the end of lifetime.

Notes

ENGLISH

Notes