

BSH-150

INDOOR AND OUTDOOR ACTIVE
INFRARED BARRIER
WITH 4 BEAMS OF PROTECTION

INSTALLATION MANUAL

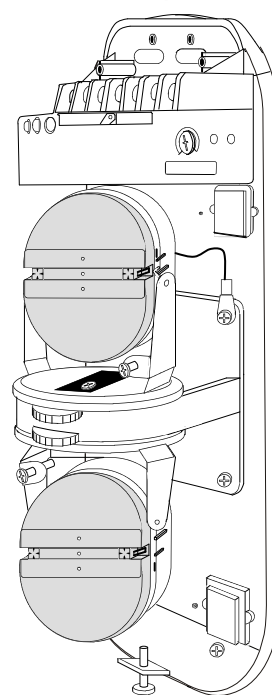
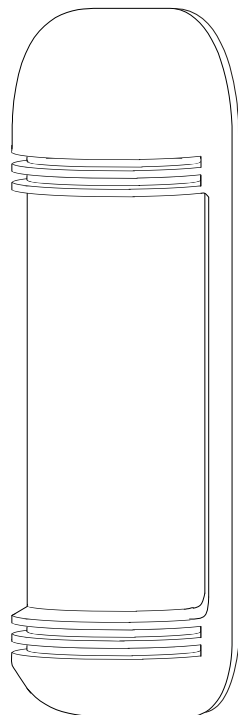

ENGLISH

1 - Product description

The **BSH-150** is an indoor or outdoor active infrared detector with 4 beams of protection. The vertical axial can be regulated from: (+12° to -12°), the horizontal axial from (+90° to -90°) and the trigger response time from 1 to 5. (See Par. 5).

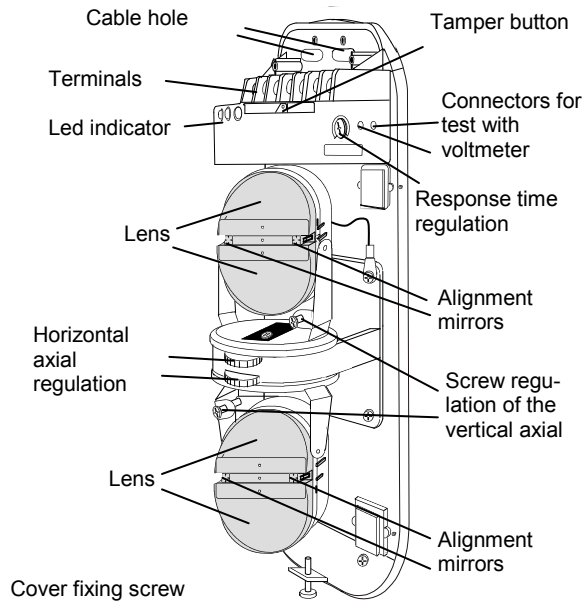
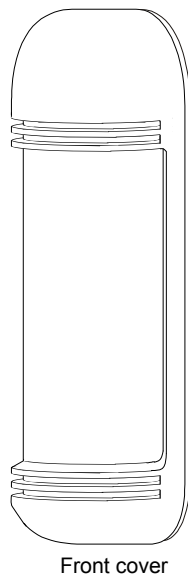

2 - Connections and indicators

TRASMITTER

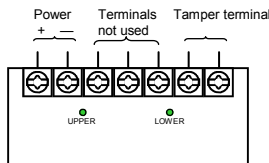

On the transmitter there are 2 green leds. The LED marked (UPPER) indicates that the 2 top beams are transmitting. The one marked (LOWER) indicates that the 2 lower beams are transmitting. The same leds, also indicate that power is present.

RICEVITORE

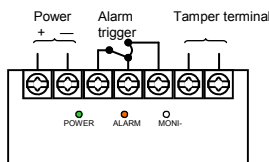

On the receiver there are 3 LED indicators: POWER LED (green) lights when power is present. ALARM LED (red) This LED will light when an alarm is triggered.

MONITOR LED (green/red) green indicates that the signal is being received. The more intense the better the signal received. Red indicates intrusion or status of pre-alarm.

Connection terminals

- 1. Not used
 - 2. Power input (+12Vd.c.)
 - 3. Negative power input
 - 4. Common (relay)
 - 5. Normally open
 - 6. Normally closed
 - 7. Tamper output
 - 8. Tamper output
- } Dry contact relay output only for receiver

Note: When the **BST-100** is in normal function, the relay on the receiver is always powered.

3 - Installation precautions

Outdoor installations: Due not install the **BST-100** where animals, trees, bushes or other plants can interrupt the line of sight of the barriers.

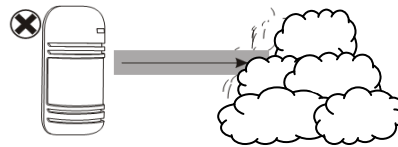

Indoor installations: Avoid that instable objects intrupt the line of sight of the barriers.

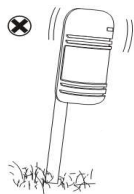

Avoid mounting the unit on columns that my not be stable.

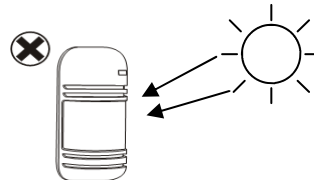

Avoid mounting the unit in direct sun light or high luminosity light sources.

Avoid that a receiver can, by error, receive the signal transmitted form the the wrong unit. See below:

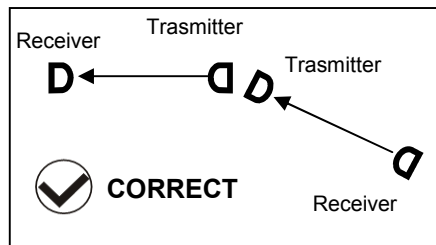
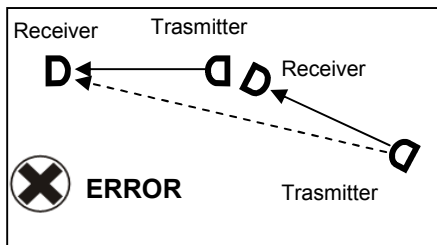

ENGLISH

3 - Installation procedure

• Wall mounting

3.1.1 Remove front cover

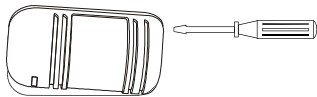

3.1.2 Using the metal base, mark on the wall the position of the fixing holes. See below:

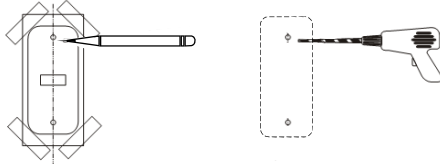

3.1.3 Insert the connection cable that comes from the control panel.

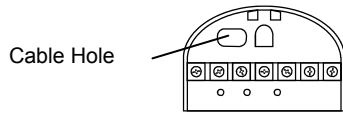

3.1.4 Fix to the wall the metal base of the sensor.

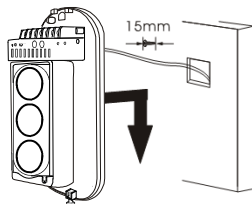

3.1.5 Connect the cable to the desired terminal blocks



See fig. page 2 for terminal conn.

• Installation on column

3.2.1 Drill hole for the cable on the top of the column



3.2.2 Remove the front cover

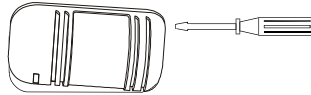

3.2.3 Fix the metal base to the Column as shown below.

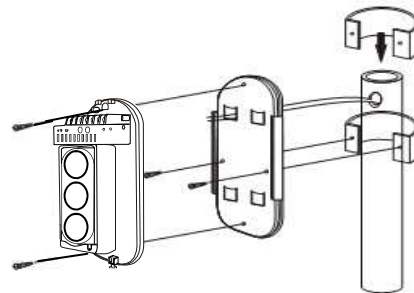

3.2.4 See below how to fix 2 units to the same column.

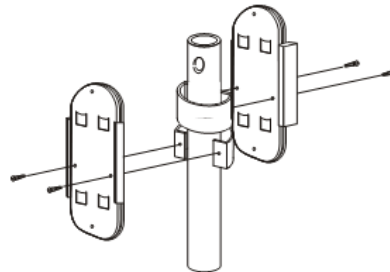

4 - Alignment of the I.R.

Visual test

1. Remove the front cover and power up both receiver and transmitter.
2. Align the beams between the transmitter and receiver.

NOTE: The more precise is the alignment, the more intense will be the luminosity of the Red Led. It is best to regulate the sensor until the luminosity is at a maximum.

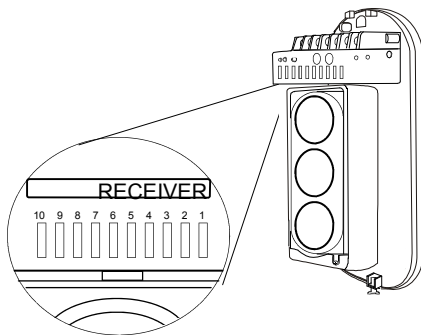

3. On the receiver, by using the vertical and horizontal alignment tools, you may better align the receiver and the transmitter. **See below.**

Testing with voltmeter

1. Insert the tester cable points based on the polarity in the holes marked (+ and -)
2. Regulate the vertical and horizontal angles until the voltage is at a maximum.

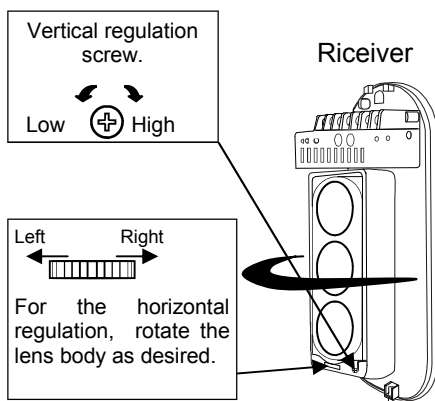
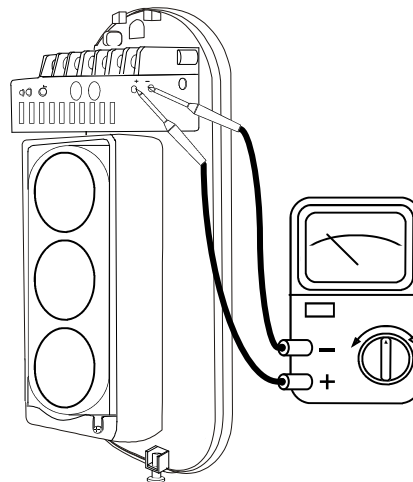





Replace the front cover and test if the active infrared barrier is functioning correctly. If not, it must be recalibrated.

ENGLISH

5 - Regulation of trigger response

With the below figures, you may regulate the trigger response time as desired.



1	 Run (6,9m/sec.)	2	 Fast Walk (1,2m/s)	3	 Normal walk (0,7m/s)	4	 Slow Movement (0,3-0,5m/s)	5	 Slow Walk (0,1-0,3m/s)
---	---	---	--	---	--	---	---	---	--

Verify the effects on the barrier based on the selected walk. If you are not satisfied with the results, change this regulation until you obtain the best possible results.

6 - Dimension

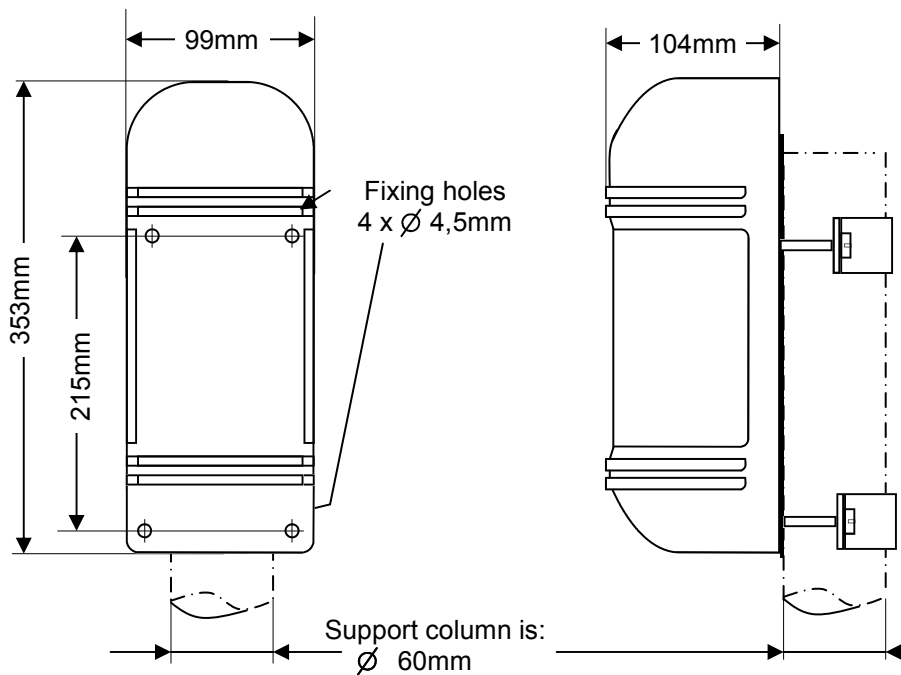

7 - In case of problems

Problem	Cause	Solution
The indicator LEDs of transmitter and receiver do not light	12 Vdc. not present or defective power source present.	Check the connection cables for short circuit or bad connection.
The ALARM LED does not light and the alarm trigger relay does not change state if both beams are interrupted.	1- Check if the receiver is getting the barrier signal from another near by transmitter. 2- Check if both beams are interrupted at the same time. 3- Check if the trigger response time is correctly set.	1- Remove the transmitter that is causing the interference. 2- Make sure that both beams are interrupted 3- Regulate the trigger response time so that the unit will function correctly.
The ALARM LED lights when both IR beams are interrupted but the control panel does not receive the trigger alarm signal.	1- Check the terminal connections and if there is an open or short circuit. 2- Check for error on the terminal connections.	1- Check for damaged cables 2- Check that the terminal connection are correct.
ALARM trigger LED is always light.	1- The IR beams are not aligned. 2- There is something that prevents the IR beam from arriving. 3- The sensor cover is very dirty.	1- Re-align the IR beams and test. 2- Remove any obstacles that can prevent the IR beams to arrive 3- Clean the sensor cover.
False alarm signal	1- Bad cable connections to the control panel. 2- Bad 12 Vdc. Power source. 3- Obstacles present that will interrupt the IR beams always or only when there is wind 4- Instable colour 5- The signal received is not strong enough. Below 2.3 V. 6- The trigger response time is not correct.	1- Check that the cables make good connection. 2- Check that the input power is okay. 3- Remove all obstacles or change the IR beam path. 4- Change or fix better the support 5- Re-align the the IR beams 6- Change the trigger response time so that the unit works correctly.

8 - Technical Characteristics

MAXIMUM RANGE	Indoor 450 mt. Outdoor 150 mt.
NUMBER OF BEAMS	4
OPERATING MODE	Interruption of both beams together
TECHNOLOGY IR TRANSMISSION ...	Active Infrared
RESPONSE TIME	From 35 to 700 Msec
ALARM OUTPUT	30 V. 0,5 mA max. (a.c. or d.c.)
POWER	From 10,5 to 18 Vd.c.
CURRENT DRAIN	100 mA max.
FUNCTIONING TEMPERATURE.....	Da -25°C to +55°C (from 5% to 95% humidity)
HORIZONTAL ANGLE.....	180° (-90°+ 90°)
VERTICAL ANGLE	20° (-10°+ 10°)
SENSOR MATERIAL	ABS
WEIGHT.....	Trasmitter 870 g - Riceiver 890 g



TRE i SYSTEMS S.r.l.

Via del Melograno N. 13 - 00040 Ariccia, Roma Italy

Tel: +39 06 97249118 Fax: +39 06 45557618

e-mail m.tomasino@treisystems.com

Website: www.treisystems.com

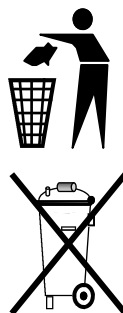

Dispose of all waste material in appropriate garbage disposal containers. Based on the local laws, if necessary, separate the different materials before disposal.

Tre i Systems is not responsible for inappropriate use or installation of the products manufactured.
For any problems contact the nearest authorized Tre i Systems sales office or service center.

Tre i Systems reserves the right to change or make improvements to this product without previous notice.

Last revision 07-02-2013